



CONSCIOUS ELEGANCE

Laat u verleiden door Element4





MAAK KENNIS MET DE NIEUWSTE GENERATIE ELEKTRISCHE HAARDEN!

Bent u op zoek naar een elektrische haard met een realistisch vlambeeld én stijlvol design? Dan kiest u voor een haard van Element4. Een absolute innovatie binnen de wereld van elektrische haarden, speciaal bestemd voor bewuste consumenten zoals u.

*Een haard die matcht
met uw DNA*

Bent u iemand die graag vooruitkijkt? Die bewuste keuzes maakt met het oog op de toekomst, maar tegelijkertijd kritisch is als het gaat om design en techniek? Dan is een elektrische haard van Element4 iets voor u. Onze elektrische haarden onderscheiden zich door een schitterend vlambeeld, ingebouwde verwarming, uiteenlopende inbouwmogelijkheden en een bijna onzichtbare glasplaat. In combinatie met de laatste ledtechnologie en handige bediening via uw app, is deze unieke haard een absolute innovatie in de wereld van elektrische haarden.

HOLLANDSE NUCHTERHEID MET MONDIALE ALLURE

Element4 is een op en top Nederlands merk. We zijn praktisch en nuchter, maar wel met een sterke focus op design. Dat zorgt ervoor dat onze haarden wereldwijd geliefd zijn onder designers, architecten en trendbewuste consumenten. Zoals het echte 'Dutchies' betaamt, is techniek bij ons een belangrijk aandachtspunt. Daarom zijn onze elektrische haarden bedienbaar met de app, beschikken ze over de nieuwste ledtechnologie én anti-reflectieglas. Het eindresultaat? Een bijzonder stijlvolle elektrische haard, met een verrassend realistisch effect.

CONTENTS

06 APPBEDIENING

07 ANTI-REFLECTIEGLAS

08 ULTRA HD
LEDTECHNOLOGIE

10 REALISTISCHE HOUTSET

12 ONZE HAARDEN





14

FRONTHAARDEN 14

MODORE 50 E	16
MODORE 80H E	18
MODORE 100 E	20
MODORE 150 E	22
MODORE 180 E	24

HOEKHAARDEN 26

BIDORE 50 E	28
BIDORE 80H E	30
BIDORE 100 E	32
BIDORE 150 E	34
BIDORE 180 E	36

3-ZIJDIGE HAARDEN 38

TRISORE 50 E	40
TRISORE 80H E	42
TRISORE 100 E	44
TRISORE 150 E	46
TRISORE 180 E	48



38

BEDIENBAAR MET UW SMARTPHONE OF TABLET

Alle elektrische haarden van Element4 zijn bedienbaar met uw smartphone of tablet. Met behulp van de gebruiksvriendelijke app kunt u het vlambeeld volledig aanpassen aan uw wensen. Zo bepaalt u tevens het verbruik van uw haard. En als u het fijn vindt zet u op afstand de ingebouwde verwarming aan, zo geniet u meteen van een aangename warmte in uw ruimte.





ANTI-REFLECTIEGLAS VOOR REALISTISCH EFFECT

Het speciale antireflectieglas geeft de elektrische haarden van Element4 een bijzonder effect. U heeft nauwelijks door dat er een glasplaat voor de haard zit. In combinatie met het realistische vlambeeld haalt u het echte 'open haard-gevoel' in huis.





ULTRA HD LEDTECHNOLOGIE

Uw haard beschikt standaard over Ultra HD Ledtechnologie. Dit zorgt voor een diep en rijk vlambeeld en creëert, dankzij het unieke reflecterende vermogen, het effect van hete as in het branderbed. De leds kunnen tot wel 50.000 branduren maken en het vlambeeld is volledig instelbaar met uw smartphone of tablet. In combinatie met het speciale anti-reflectieglas én het unieke flikkerende effect van de vlammen ontstaat er een bewegelijk en realistisch beeld.

KIES UW FAVORIETE HOUTSET

Geniet u het liefst van een authentiek vuur, met de herkenbare warmbruine houtblokken? Dan kiest u voor 'Woodland'. Houdt u van een koelere houttint die past binnen een strak interieur? Dan is de houtset Zilverberk een goede keuze voor u.



WOODLAND



ZILVERBERK



OP ZOEK NAAR EEN STIJLVOLLE ELEKTRISCHE HAARD DIE UW INTERIEUR VERRIJKT?

Maak kennis met de veelzijdige collectie elektrische haarden van Element4. Of u nu kiest voor een fronthaard, hoekhaard of 3-zijdige haard; onze elektrische haarden staan garant voor een zeer realistisch vlambeeld en uiteenlopende inbouw mogelijkheden. Bovendien zijn ze standaard uitgerust met ingebouwde verwarming en bijna onzichtbare glasplaat. Dat maakt elke haard uit onze collectie een aanwinst voor uw interieur.









Introductie

FRONTHAARDEN

De fronthaard is een echte klassieker onder de haarden. Dit type haard beschikt over één glasplaat en biedt aan de voorzijde een schitterend uitzicht op het vuur. U kunt de fronthaard perfect toepassen in een schouw of bijpassende ombouw. U heeft al een elektrische fronthaard vanaf slechts 25 centimeter inbouwdiepte. Zo maakt u optimaal gebruik van de (beperkte) ruimte. Laat u inspireren door onze collectie en ontdek welke fronthaard het beste aansluit bij uw wensen.



MODORE 50 E



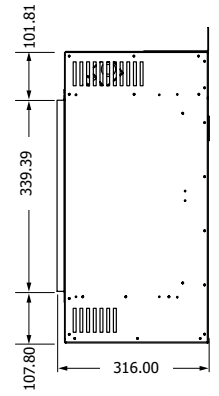
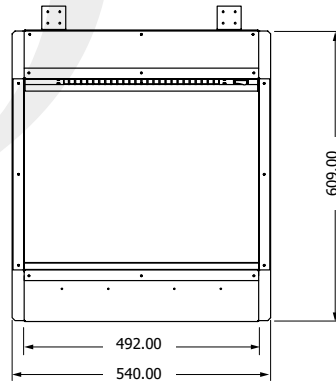
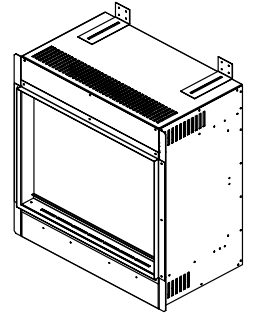
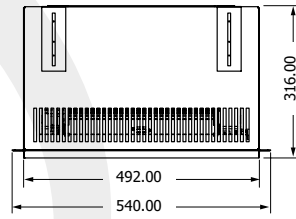



 495 mm ultra hd effect
 1 & 2 kW heat outputs

 Anti-reflective glass: Standaard
 Houtset: Woodland of zilverberk

MODORE 80H E

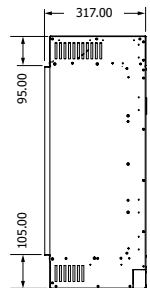
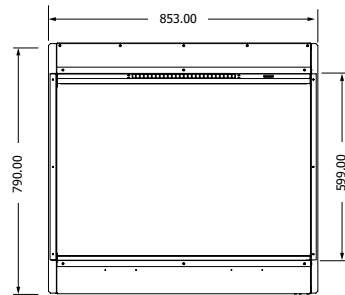
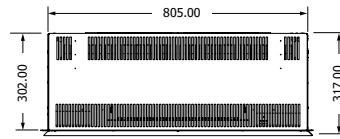





 800 mm ultra hd effect
 1 & 2 kW heat outputs

 Anti-reflective glass: Standaard
 Houtset: Woodland of zilverberk

MODORE 100 E

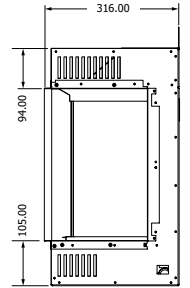
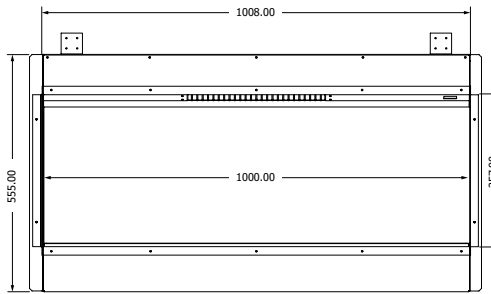
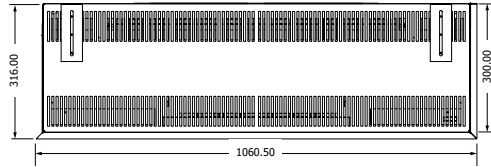





 1000 mm ultra hd effect
 1 & 2 kW heat outputs

 Anti-reflective glass: Standaard
 Houtset: Woodland of zilverberk

MODORE 150 E

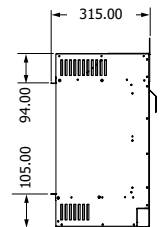
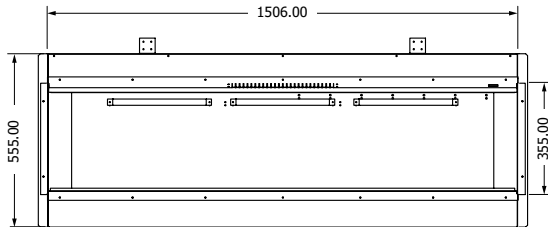
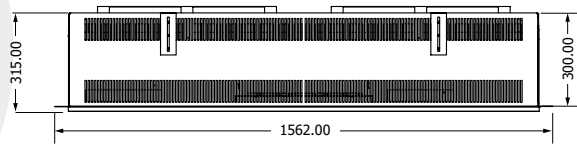



 1500 mm ultra hd effect
 1 & 2 kW heat outputs

 Anti-reflective glass: Standaard
 Houtset: Woodland of zilverberk

MODORE 180 E



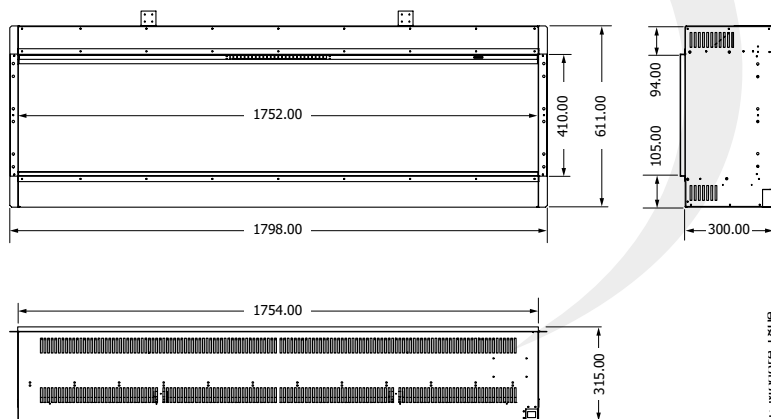

MODEL: PRODUCTIE LOUPE

 1750 mm ultra hd effect
1 & 2 kW heat outputs

 Anti-reflective glass: Standaard
Houtset: Woodland of zilverberk





Introductie

HOEKHAARDEN

Met een hoekhaard creëert u maximale sfeer in uw ruimte. Dit type haard biedt ruim zicht op het schitterende vlammenpel en zorgt voor nóg meer sfeerbeleving dankzij de extra ruit. Element4 biedt keuze uit diverse afmetingen, inbouwmogelijkheden en vermogens. Zo vindt u altijd een elektrische hoekhaard die aansluit bij uw inbouwsituatie en interieur.



BIDORE 50 E



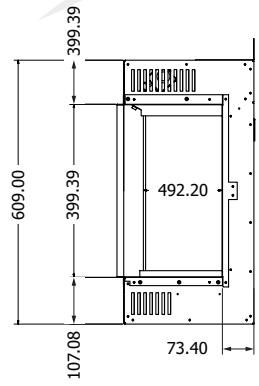
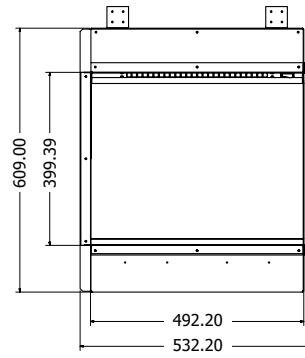
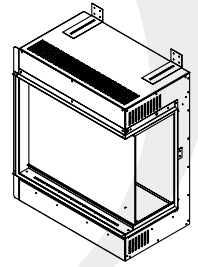
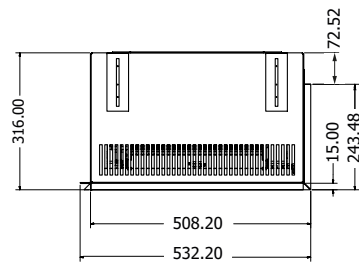



 495 mm ultra hd effect
 1 & 2 kW heat outputs

 Anti-reflective glass: Standaard
 Houtset: Woodland of zilverberk

BIDORE 80H E

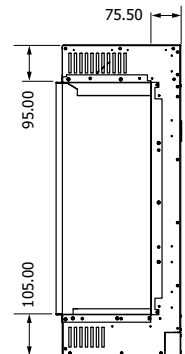
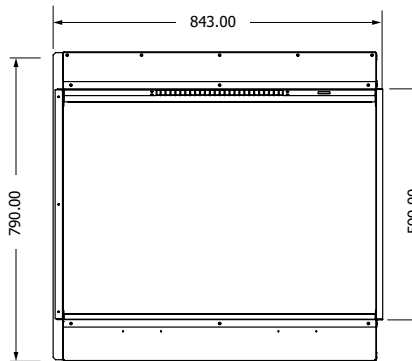
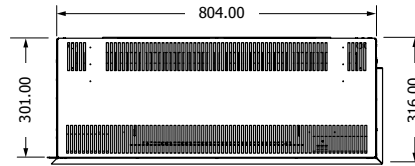





 800 mm ultra hd effect
 1 & 2 kW heat outputs

 Anti-reflective glass: Standaard
 Houtset: Woodland of zilverberk

BIDORE 100 E

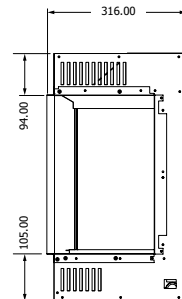
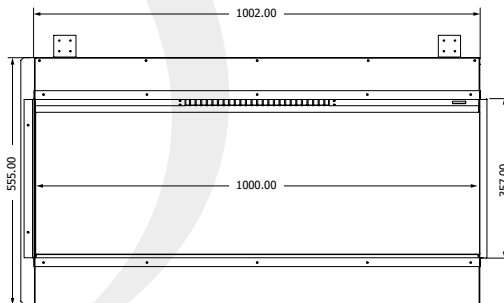
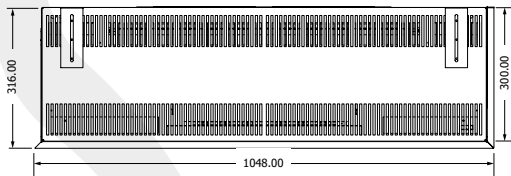





 1000 mm ultra hd effect
 1 & 2 kW heat outputs

 Anti-reflective glass: Standaard
 Houtset: Woodland of zilverberk

BIDORE 150 E

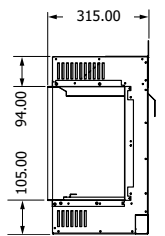
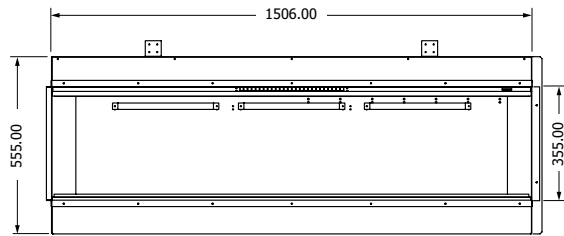
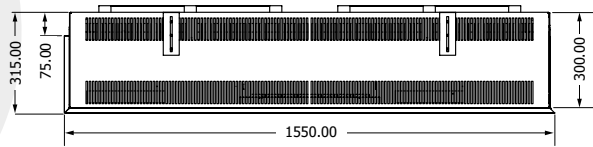



 1500 mm ultra hd effect
1 & 2 kW heat outputs

 Anti-reflective glass: Standaard
Houtset: Woodland of zilverberk

BIDORE 180 E



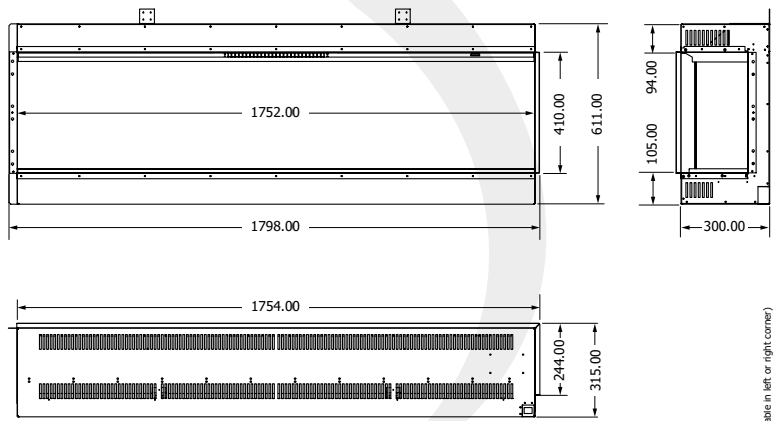

(available in left or right corner)



 1750 mm ultra hd effect
1 & 2 kW heat outputs

 Anti-reflective glass: Standaard
Houtset: Woodland of zilverberk





Introdunctie

3-ZIJDIGE HAARDEN

De 3-zijdige elektrische haard beschikt over drie zijden, waardoor u vanuit meerdere richtingen zicht heeft op het vuur. Dankzij het gebruik van meerdere glasplaten kunt u deze haard op diverse creatieve manieren toepassen binnen uw interieur. Element4 biedt voor elke smaak en stijl een geschikt model, leverbaar in diverse afmetingen. Laat u inspireren door de collectie en vind de 3-zijdige elektrische haard die bij u past.



TRISORE 50 E



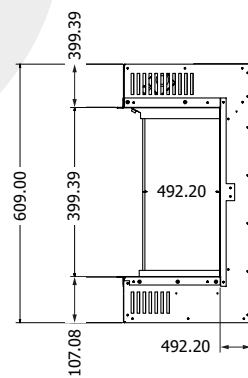
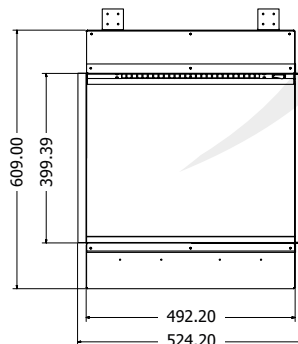
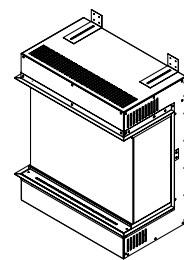
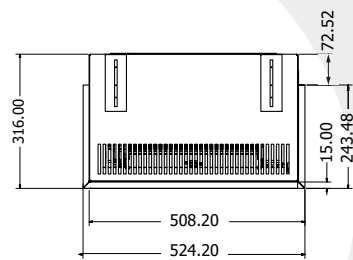

495 mm ultra hd effect
1 & 2 kW heat outputs





Anti-reflective glass: Standaard
Houtset: Woodland of zilverberk

TRISORE 80H E

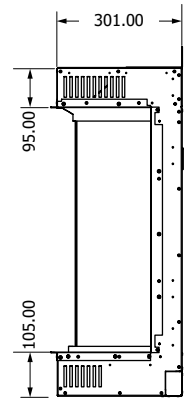
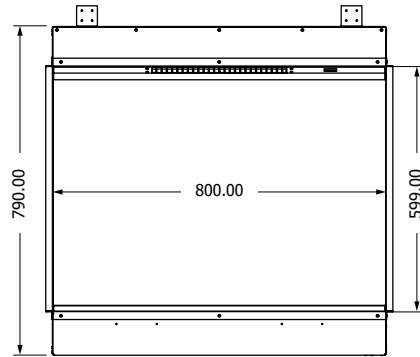
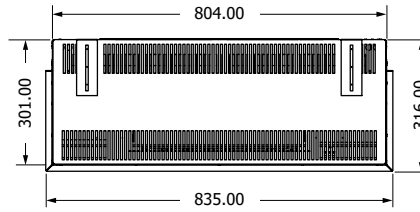





 800 mm ultra hd effect
 1 & 2 kW heat outputs

 Anti-reflective glass: Standaard
 Houtset: Woodland of silverberk

TRISORE 100 E

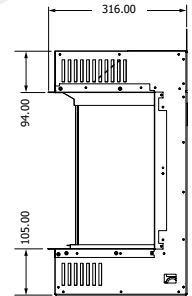
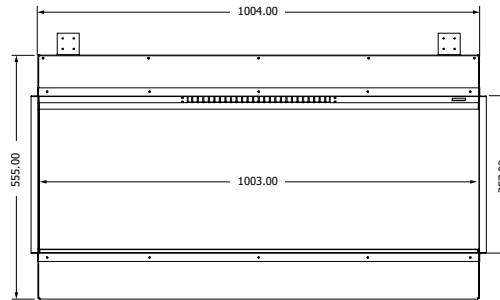
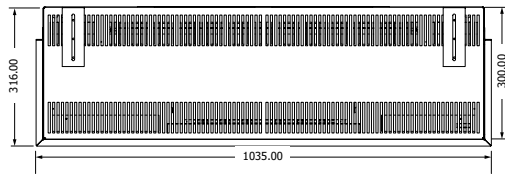





 1000 mm ultra hd effect
 1 & 2 kW heat outputs

 Anti-reflective glass: Standaard
 Houtset: Woodland of zilverberk

TRISORE 150 E

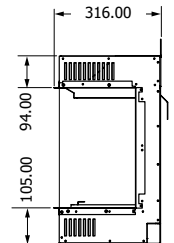
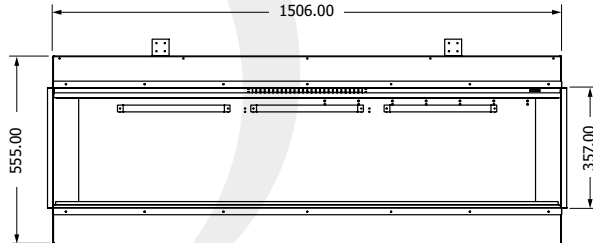
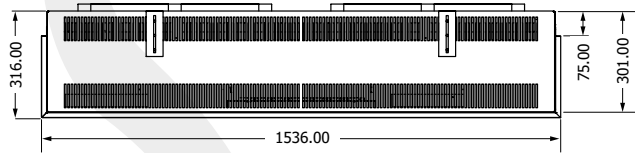





 1500 mm ultra hd effect
 1 & 2 kW heat outputs

 Anti-reflective glass: Standaard
 Houtset: Woodland of zilverberk

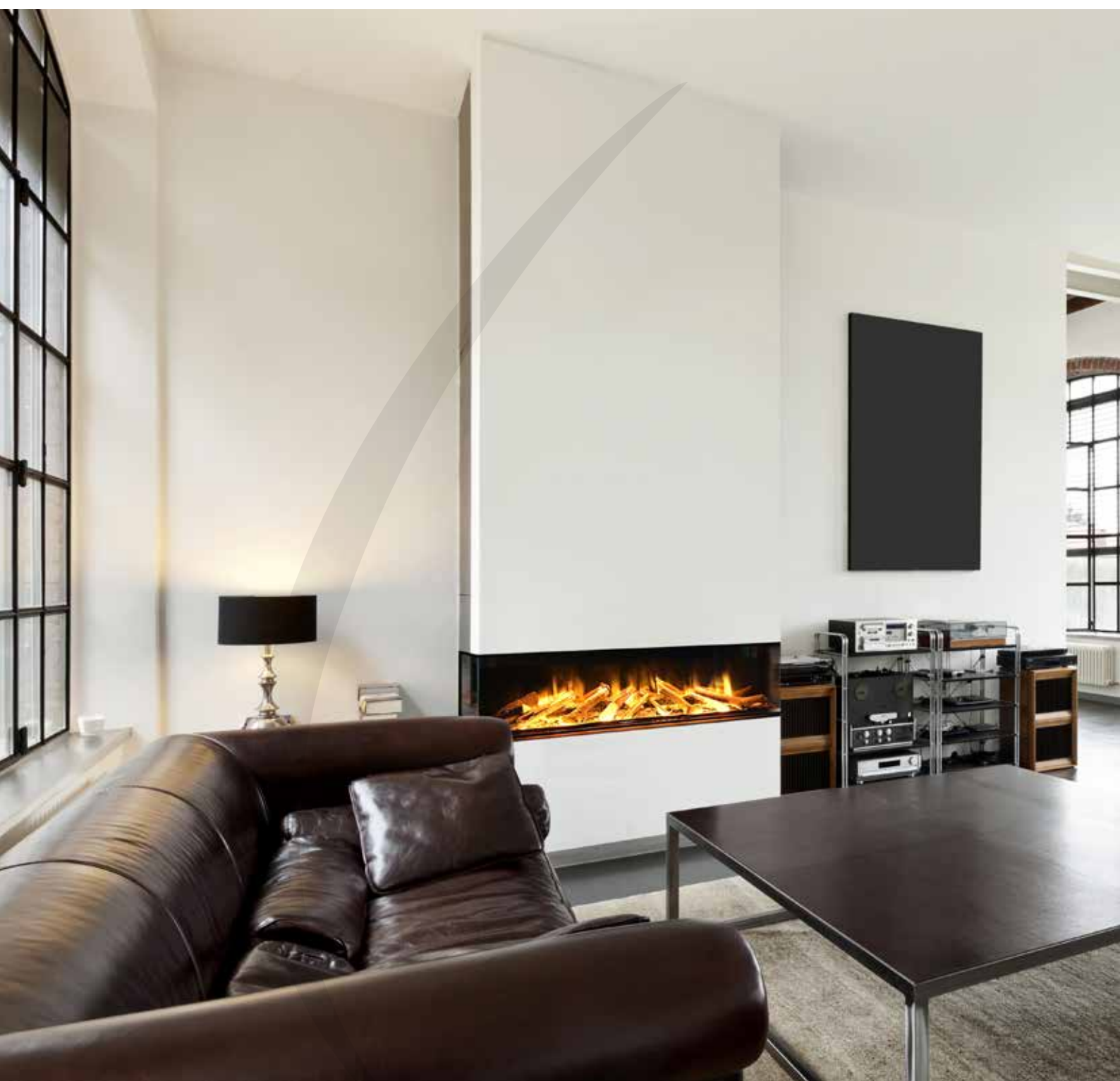
TRISORE 180 E

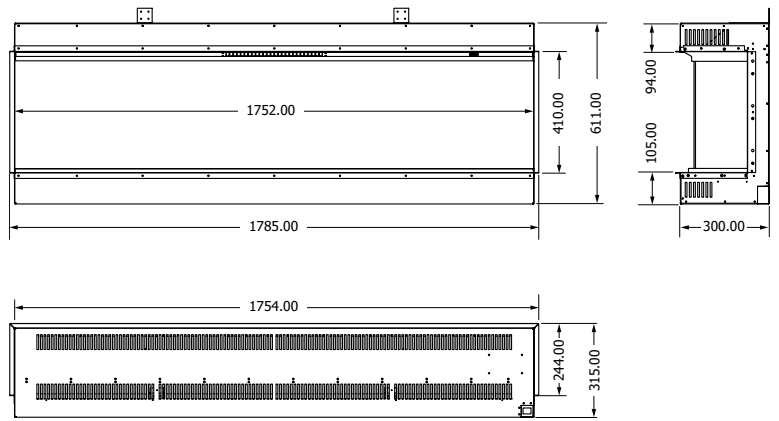



 1750 mm ultra hd effect
1 & 2 kW heat outputs

 Anti-reflective glass: Standaard
Houtset: Woodland of zilverberk

LAAT U INSPIREREN DOOR ONZE ANDERE COLLECTIES

Element4 is een veelzijdig en ambitieus merk. We lopen graag een stapje voor en breiden ons assortiment regelmatig uit met stijlvolle nieuwkomers. Als u wilt kunt u tegenwoordig ál uw favoriete verblijfslocaties uitrusten met een haard van Element4, of dat nu uw woning, bedrijfspand of tuin is. Nieuwsgierig? Bekijk dan snel onze andere collecties!



Surf naar www.element4.com/brochure en vraag de brochures aan!

ELEMENT
GAS FIRES **4** 

ELEMENT
CLUB SERIES **4** 



Element4 heeft altijd de juiste haard
voor u

ELEMENT 4 
OUTDOOR FIRES



ELEMENT
ELECTRIC FIRES **4**



BROCHURE 2018

Paxtonstraat 23
8013 RP Zwolle
Netherlands

+31 (0)38 420 90 20
info@element4.nl
www.element4.nl